

NO. A-22689-1

PUMP PERFORMANCE CURVES

TYPE Submersible Centrifugal Wastewater Pump	MODEL 80NH24.0 -61	FREQUENCY 60 Hz
--	--------------------	-----------------

CUSTOMER'S NAME _____

EQUIPMENT TITLE _____ NO. _____

	STANDARD SPECIFICATIONS	REQUIRED SPECIFICATIONS
DISCHARGE BORE	80 mm	mm
TOTAL HEAD	MAX 27.4 m	m
CAPACITY	MAX 1.0 m ³ /min	m ³ /min
MOTOR OUTPUT	4 kW	kW
PHASE x VOLTAGE	3 ϕ x V	ϕ x V
CURRENT	A	A
POLES / REVOLUTION	2 P / S. S. 3600 min ⁻¹	P / min ⁻¹
STARTING METHOD	DIRECT ON LINE	
INSULATION CLASS	F	

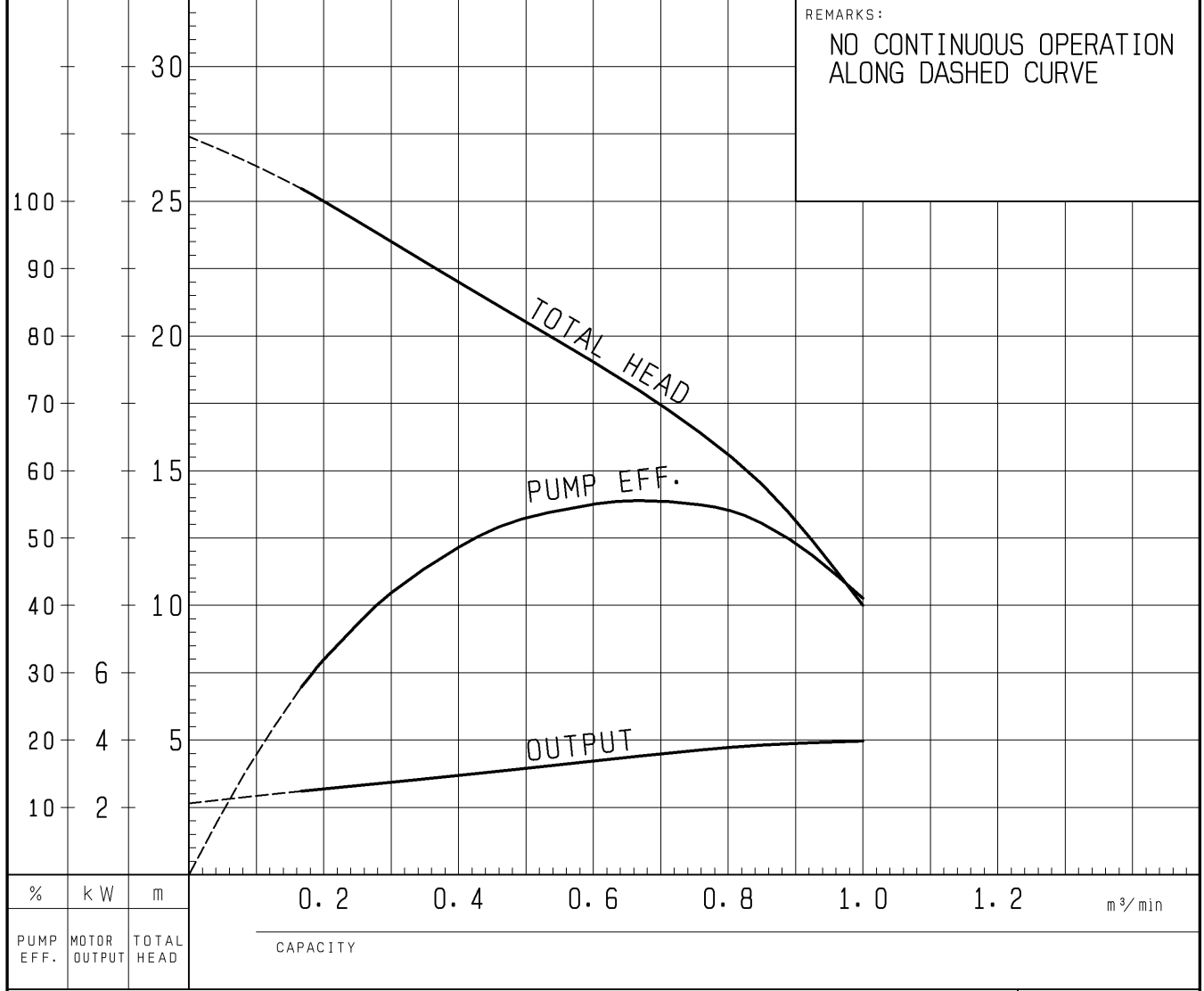

TSURUMI MFG. CO., LTD.

DIMENSION DRAWING		No.	No.	A-21965-2
TYPE	Submersible Centrifugal Wastewater Pump	MODEL	50NH23.0 -51/61 50/80NH24.0 -51/61	

MODEL	d	A	A1	A2	A3	B	D	D1	W1	W2	H	Approximate Weight(※)
50NH23.0-51/61	50	455	113	166	264	182	236	105	335	143	540	50kg
50NH24.0-51/61	50	496	123	198	296	185	260	123	351	146	557	56kg
80NH24.0-51/61	80	522	123	195	307	250	256	123	357	156	563	61kg

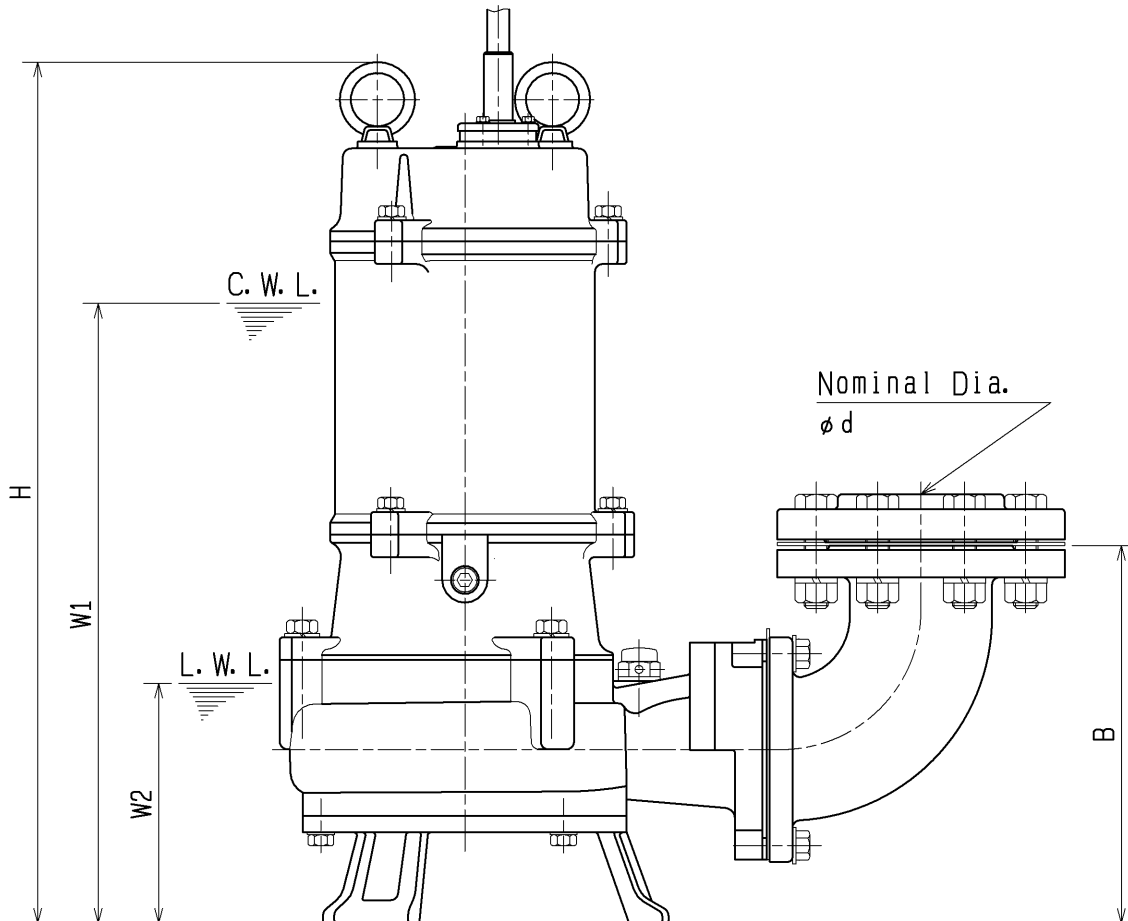
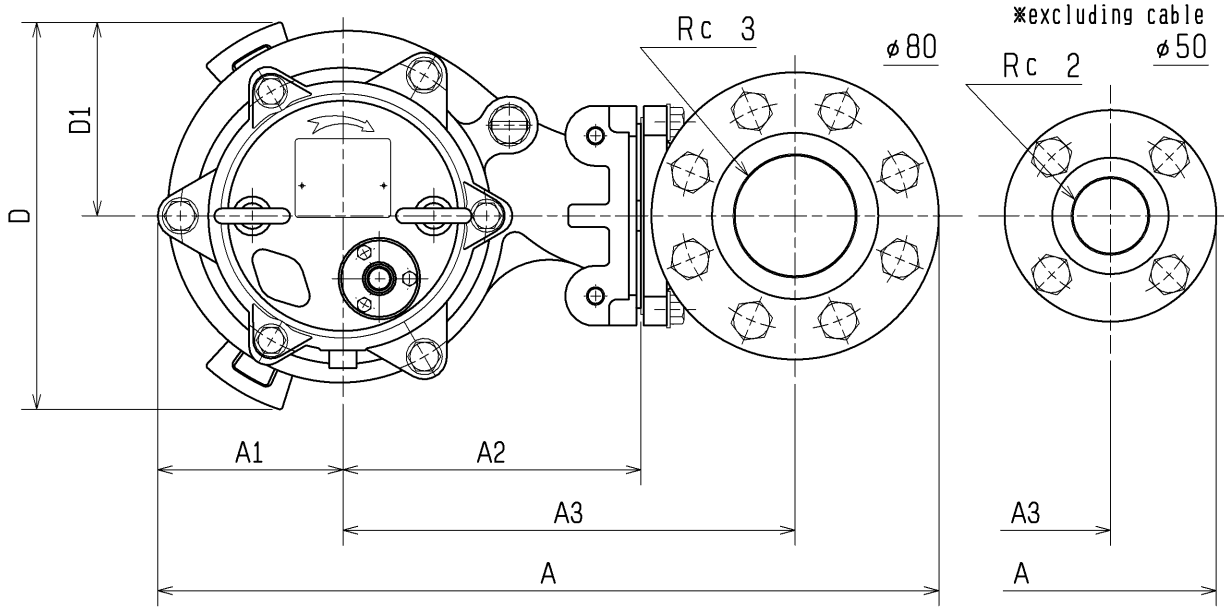

C. W. L. :Continuous running Water Level
L. W. L. :Lowest running Water Level

SECTIONAL DRAWING		No.	No. A-21967-2
TYPE	Submersible Centrifugal Wastewater Pump	MODEL	50NH21.5 -51/61, 50NH22.2 -51/61 50NH23.0 -51/61, 50/80NH24.0 -51/61

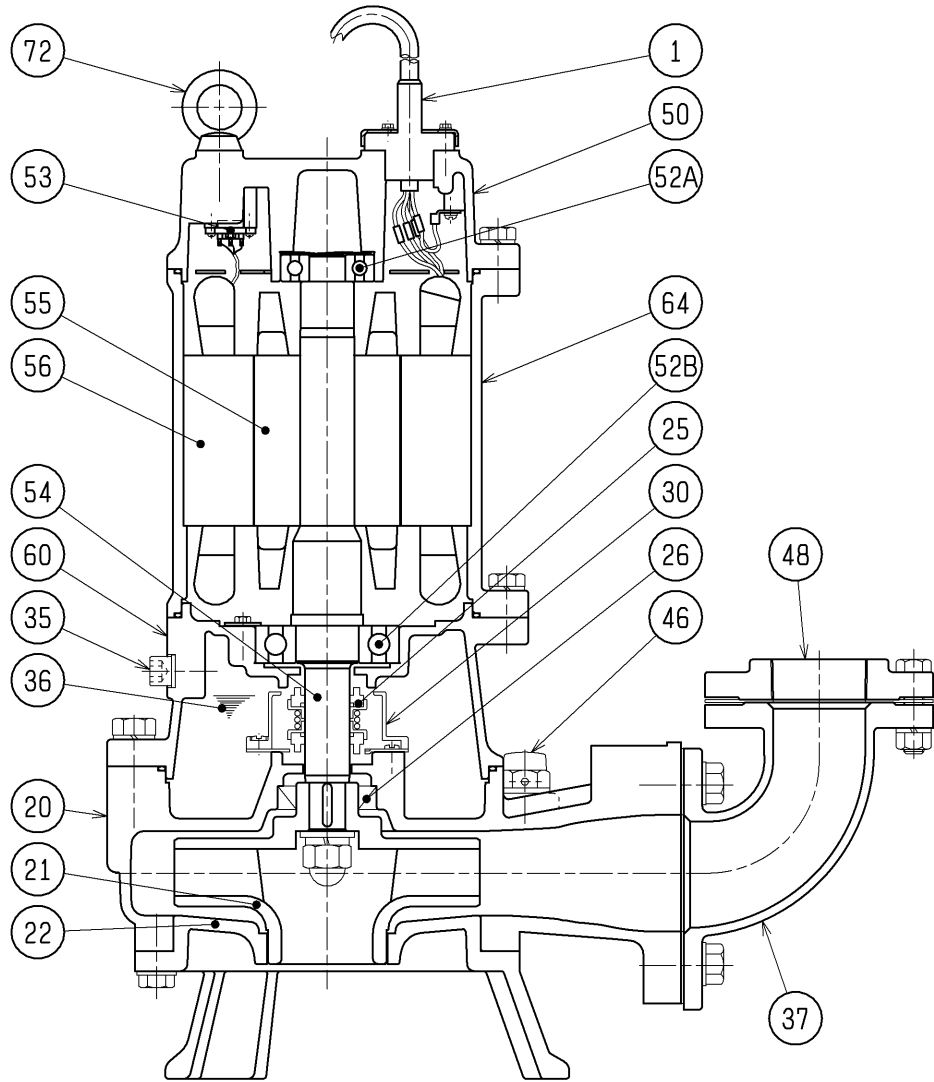

* the wetted part

	1.5kW	2.2kW	3.0kW	4.0kW
※1	φ20		φ25	
※2	32477		355512	
※3	6204ZZC3		6304ZZC3	
※4	6305ZZC3	6306ZZC3	6307ZZC3	
※5	Stainless Steel 420J1		Stainless Steel 420J1(*)	

REQ. SPECIFICATION		

No.	DESCRIPTION	QTY	MATERIAL / NOTE	No.	DESCRIPTION	QTY	MATERIAL / NOTE
1	Cable	1	Chloroprene Sheath	50	Motor Bracket	1	Gray Iron Casting
20	Pump Casing	1	Gray Iron Casting	52A	Upper Bearing	1	※3
21	Impeller	1	Gray Iron Casting	52B	Lower Bearing	1	※4
22	Suction Cover	1	Gray Iron Casting	53	Motor Protector	1	
25	Mechanical Seal	1	※1	54	Shaft	1	※5
26	Oil Seal	1	※2	55	Rotor	1	
30	Oil Lifter	1	Plastic	56	Stator	1	
35	Oil Plug	1	Stainless Steel 304	60	Bearing Housing	1	Gray Iron Casting
36	Lubricant		Turbine Oil (ISO VG32)	64	Motor Frame	1	Gray Iron Casting
37	Discharge Bend	1	Gray Iron Casting	72	Eye Bolt	2	Carbon Steel
46	Air Release Valve	1	Plastic				
48	Screwed Flange	1	Gray Iron Casting				