

Dimension in: mm

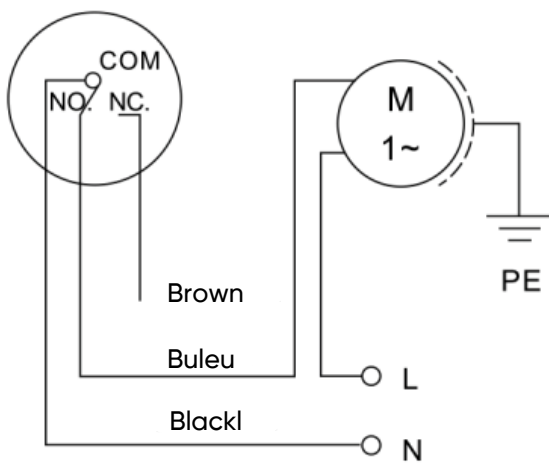

Float switch is a switch that can adjust the liquid level in a barrel, tank or well. It can be adjusted automatically, easy to operate and install, safe and reliable. It is exempted from maintenance and is nontoxic and environmentally friendly. It has resistance to sewage and is widely used in domestic, industrial and mining pool, oil, acid and alkali pools, barrels, tanks, sinks and other containers.



1. Auto-fill-water modes

Connect the control's blue line to electric pump, black lines connected to zero-line, brown line can not be connected and should be insulated.

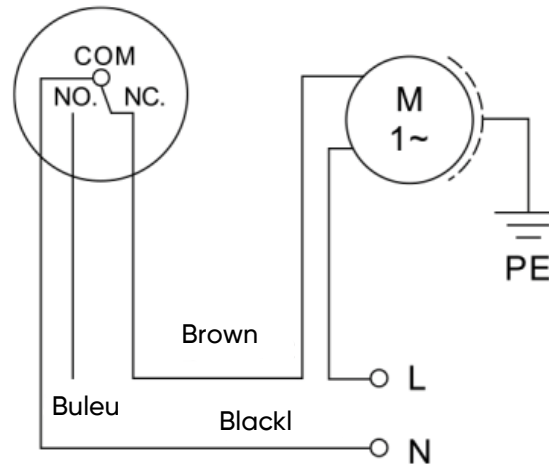

2. Auto-drainage and lack-water protection modes

Connect the control's blue line to electric pump, black lines connected to zero-line, brown line can not be connected and should be insulated.

Specification

General	NRF3M16A
Rated voltage	AC110/220V
Max.Current	AC 16(4)A
Frequency	50/60Hz
Max.Using Temperature	60
Protection Degree	Ip68